

EGRET SOLAR  
YOUR SOLAR BUTLER

EGRET SOLAR  
YOUR SOLAR BUTLER

EGRET SOLAR  
YOUR SOLAR BUTLER

EGRET SOLAR  
YOUR SOLAR BUTLER

EGRET SOLAR  
YOUR SOLAR BUTLER

EGRET SOLAR  
YOUR SOLAR BUTLER

EGRET SOLAR  
YOUR SOLAR BUTLER

EGRET SOLAR  
YOUR SOLAR BUTLER

EGRET SOLAR  
YOUR SOLAR BUTLER

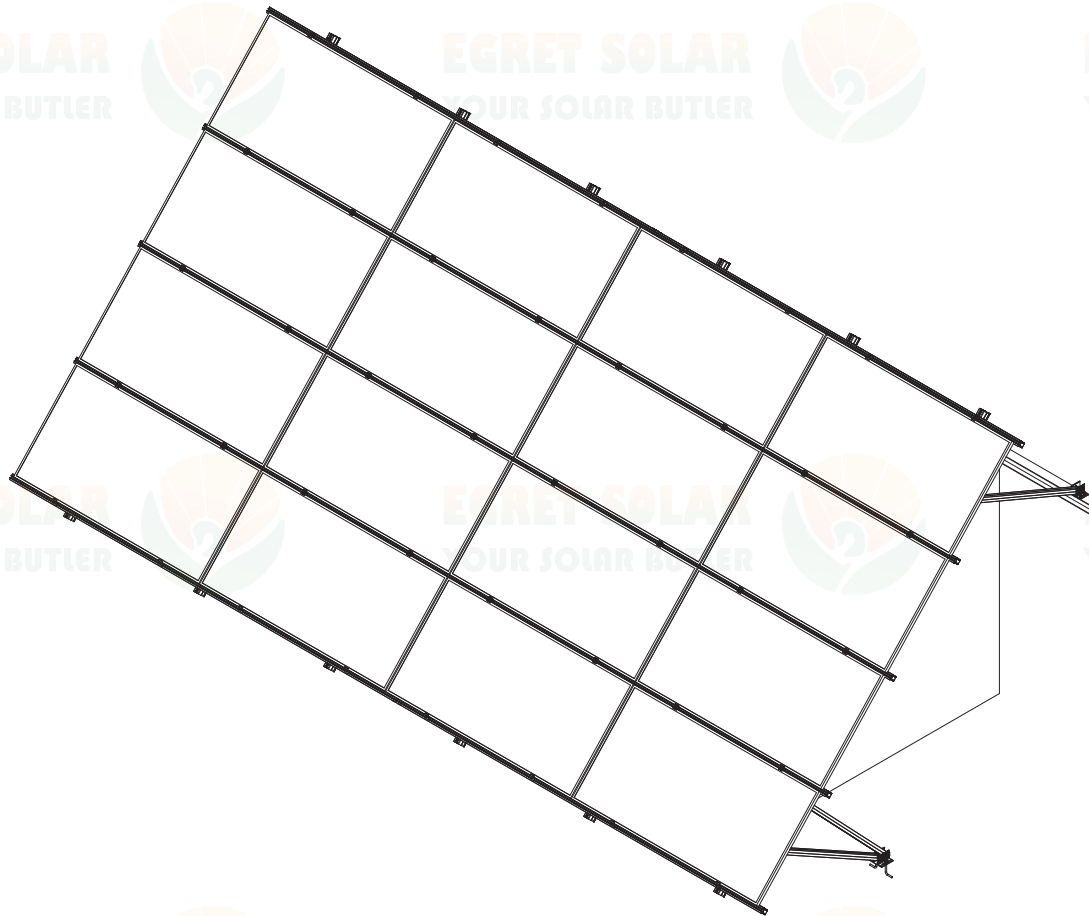

Version	Date	Approval	Change mark	Description of Change
A				

Project Name	Container systems	Project No.	EG20230510
Design		 厦门鹭伏特新能源科技有限公司 Xiamen Egret Solar New Energy Technology Co., Ltd	
Chk'D			
App'V'D			

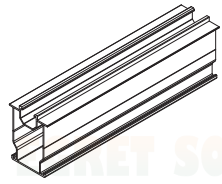

Rail

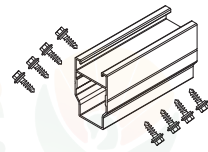

Rail Splice

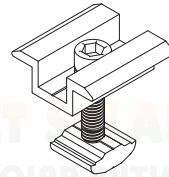

Mid Clamp

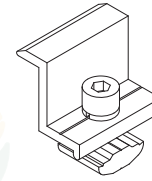

End Clamp

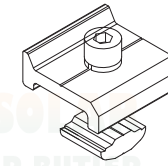

Rail Clamp

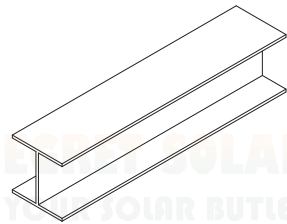

I-Beam

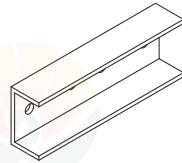

I-Beam Splice

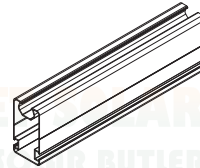

Beam

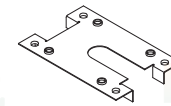

Grouding Clip

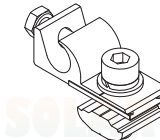

Grouding Lug

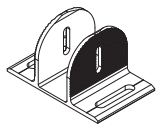

A-Base

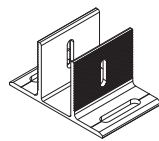

Single Hole Base

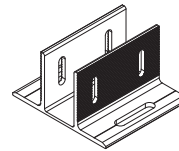

Double Hole Base



Embedded Bolts



Hoop

Version	Date	Approval	Change mark	Description of Change
A				

Project Name	Container systems	Project No.	EG20230510
Design		 厦门鹭伏特新能源科技有限公司 Xiamen Egret Solar New Energy Technology Co., Ltd	
Chk'D			
Appv'D			

EGRET SOLAR  
YOUR SOLAR BUTLER



EGRET SOLAR  
YOUR SOLAR BUTLER



EGRET SOLAR  
YOUR SOLAR BUTLER



EGRET SOLAR  
YOUR SOLAR BUTLER



EGRET SOLAR  
YOUR SOLAR BUTLER

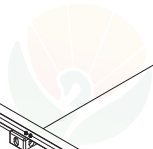

EGRET SOLAR  
YOUR SOLAR BUTLER



EGRET SOLAR  
YOUR SOLAR BUTLER



EGRET SOLAR  
YOUR SOLAR BUTLER



EGRET SOLAR  
YOUR SOLAR BUTLER

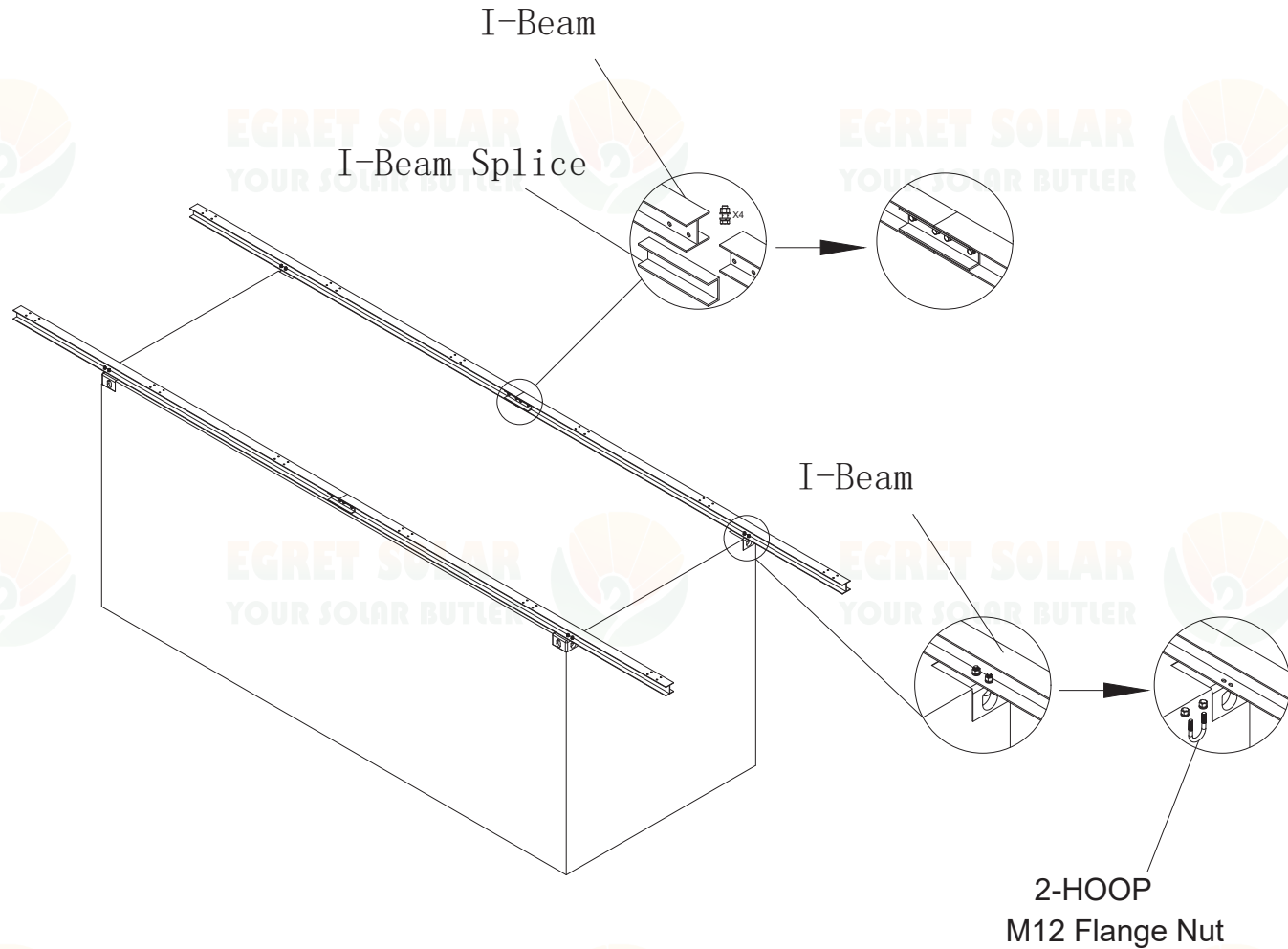

Version	Date	Approval	Change mark	Description of Change
A				

Project Name	Container systems	Project No.	EG20230510
Design		 厦门鹭伏特新能源科技有限公司 Xiamen Egret Solar New Energy Technology Co., Ltd	
Chk'D			
App'V'D			

A Base

4-Hexagon Bolt  
M12\*40

Single Hole Base

4-Hexagon Bolt  
M12\*40

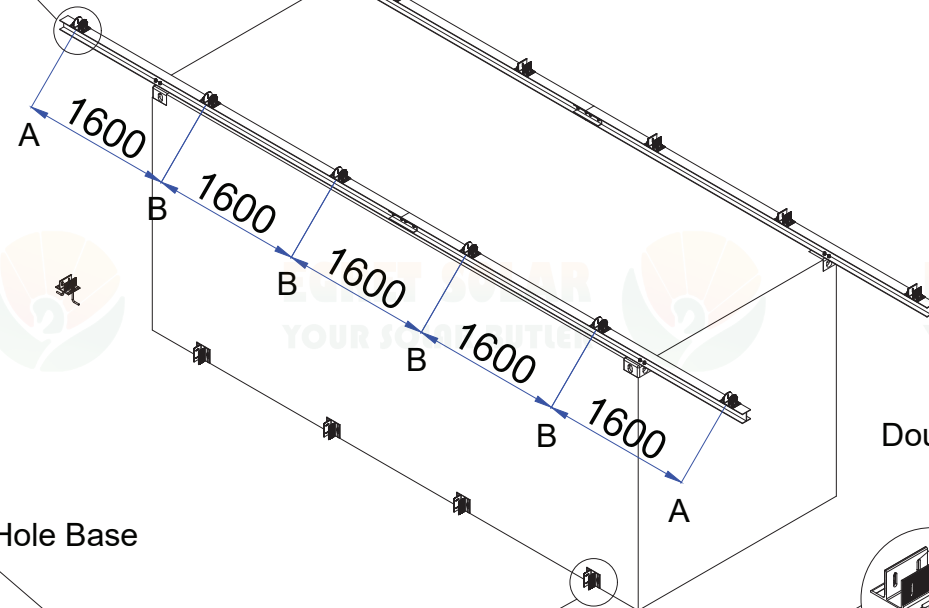
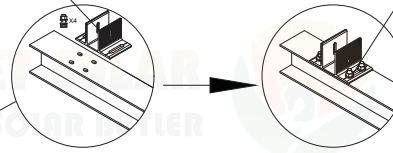
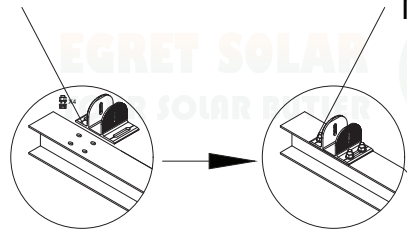

Double Hole Base

Double Hole Base

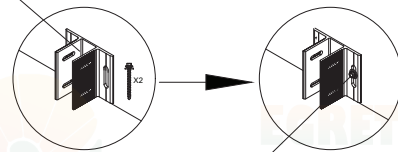

2-ST6.3

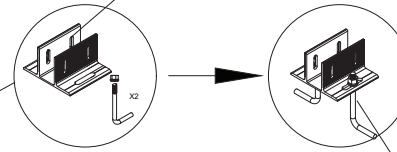

2-M12\*300 Embedded Bolts

Version	Date	Approval	Change mark	Description of Change
A				

Project Name	Container systems	Project No.	EG20230510
Design		 厦门鹭伏特新能源科技有限公司 Xiamen Egret Solar New Energy Technology Co., Ltd	
Chk'D			
App'V'D			

Hexagon Bolt  
M10\*80

Hexagon Bolt  
M10\*90

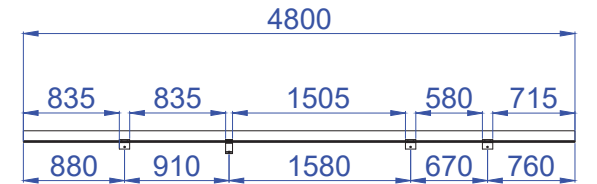
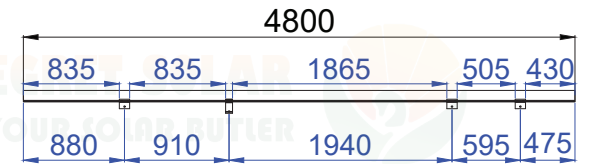
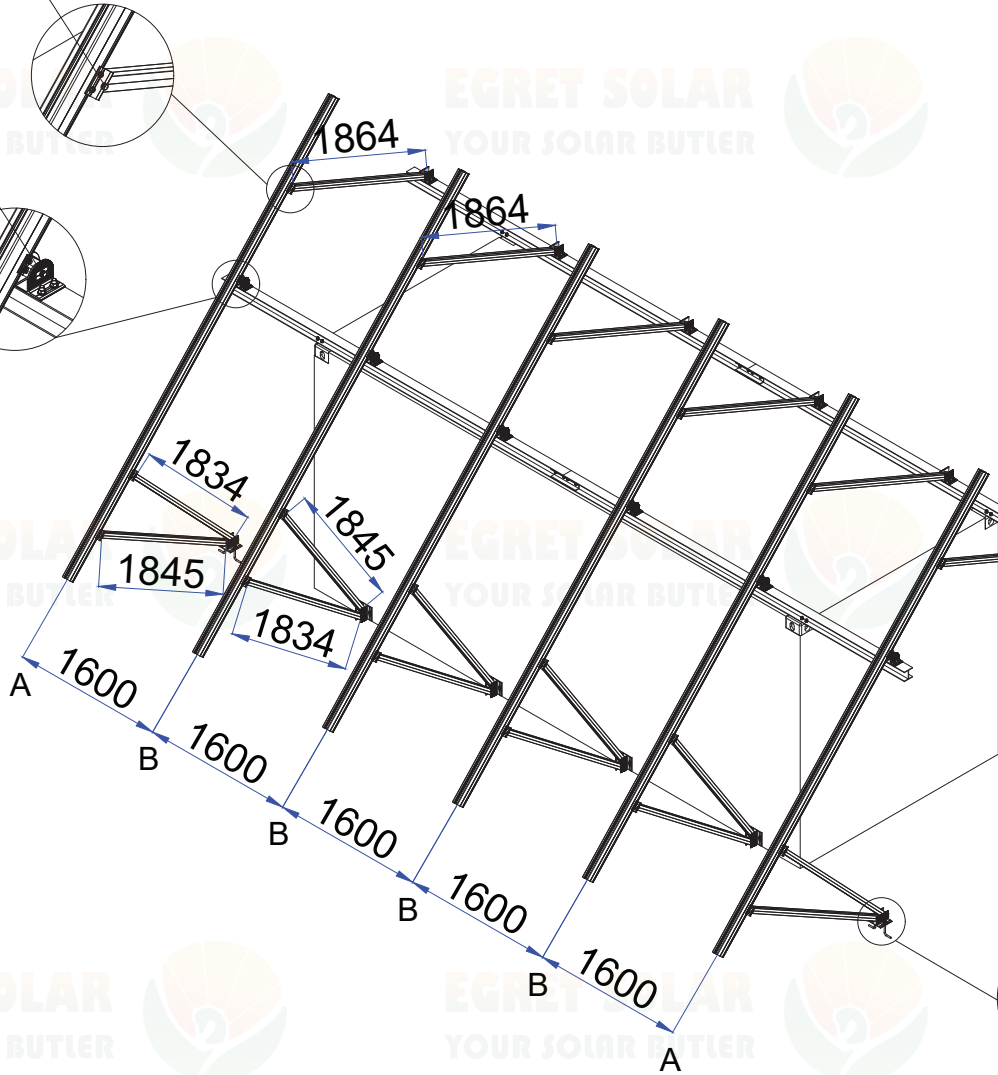

Hexagon Bolt  
M10\*90

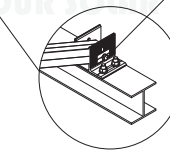

Hexagon Bolt  
M10\*90

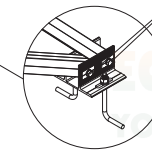

Version	Date	Approval	Change mark	Description of Change
A				

Project Name	Container systems	Project No.	EG20230510
Design		 厦门鹭伏特新能源科技有限公司 Xiamen Egret Solar New Energy Technology Co., Ltd	
Chk'D			
App'V'D			

EGRET SOLAR  
YOUR SOLAR BUTLER

EGRET SOLAR  
YOUR SOLAR BUTLER

EGRET SOLAR  
YOUR SOLAR BUTLER



EGRET SOLAR  
YOUR SOLAR BUTLER

EGRET SOLAR  
YOUR SOLAR BUTLER

EGRET SOLAR  
YOUR SOLAR BUTLER



EGRET SOLAR  
YOUR SOLAR BUTLER

EGRET SOLAR  
YOUR SOLAR BUTLER

EGRET SOLAR  
YOUR SOLAR BUTLER

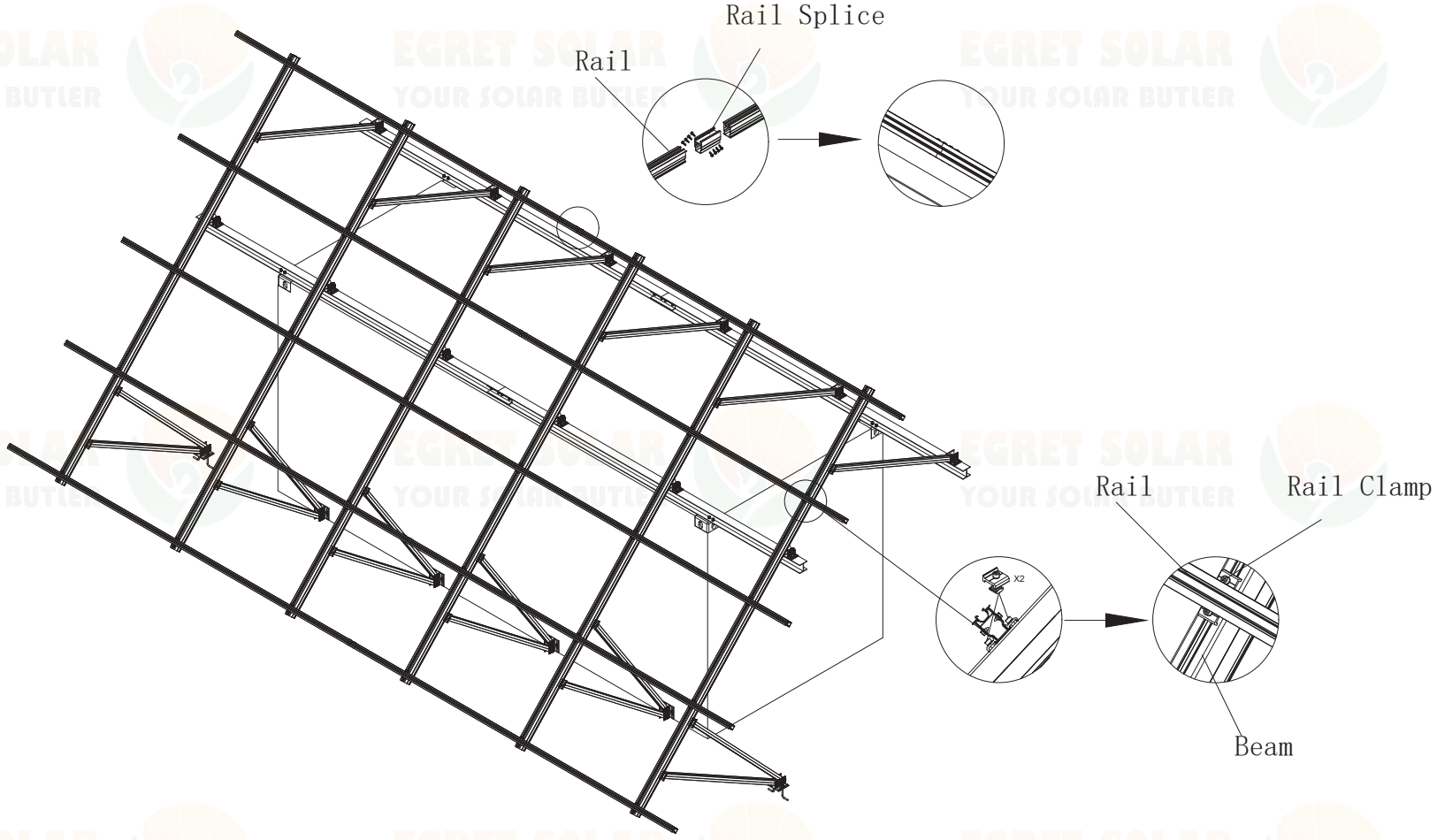

Version	Date	Approval	Change mark	Description of Change
A				

Project Name	Container systems	Project No.	EG20230510
Design		 厦门鹭伏特新能源科技有限公司 Xiamen Egret Solar New Energy Technology Co., Ltd	
Chk'D			
App'V'D			

EGRET SOLAR  
YOUR SOLAR BUTLER

EGRET SOLAR  
YOUR SOLAR BUTLER

EGRET SOLAR  
YOUR SOLAR BUTLER

EGRET SOLAR  
YOUR SOLAR BUTLER

EGRET SOLAR  
YOUR SOLAR BUTLER

EGRET SOLAR  
YOUR SOLAR BUTLER

EGRET SOLAR  
YOUR SOLAR BUTLER

EGRET SOLAR  
YOUR SOLAR BUTLER

EGRET SOLAR  
YOUR SOLAR BUTLER

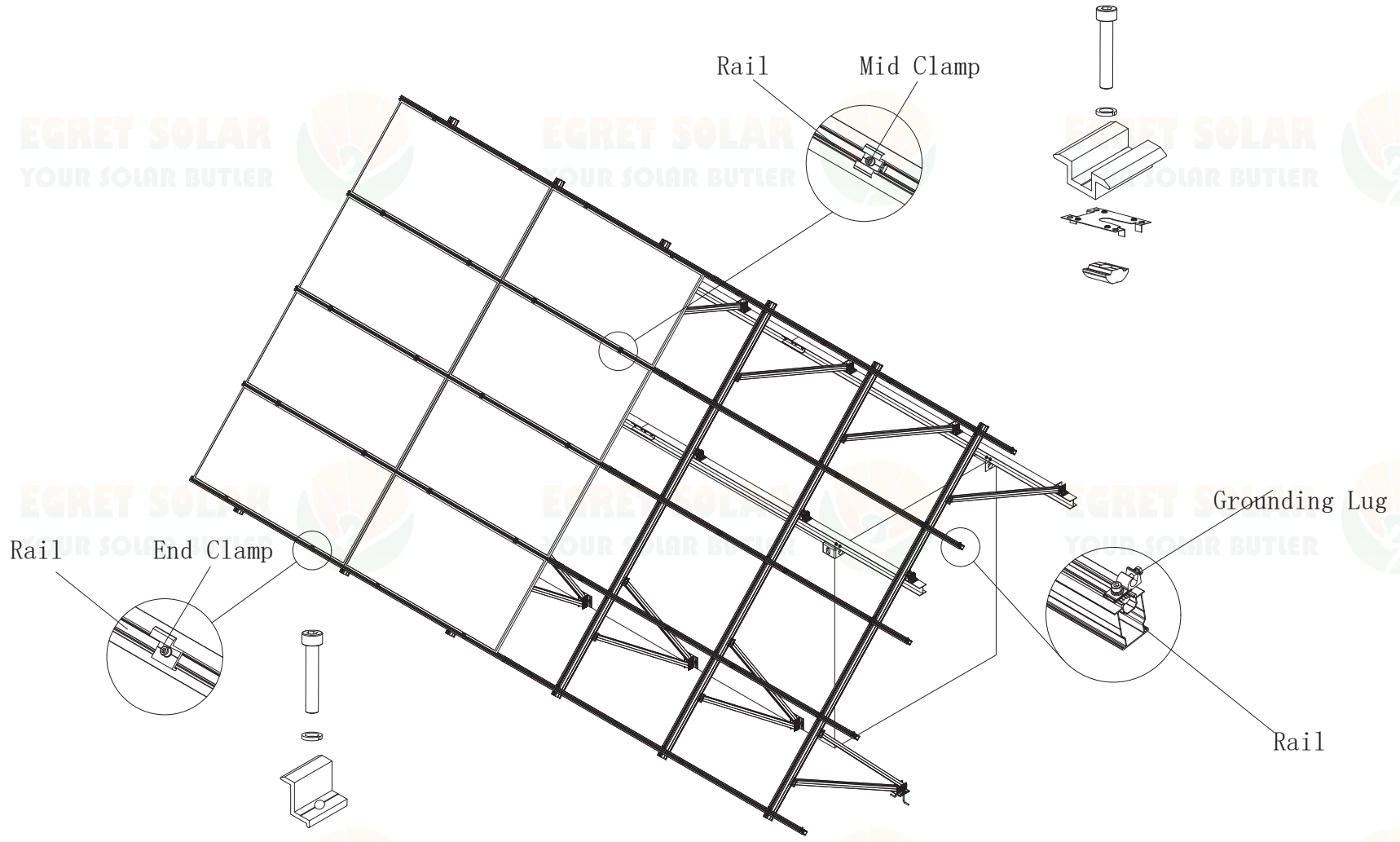

Version	Date	Approval	Change mark	Description of Change
A				

Project Name	Container systems	Project No.	EG20230510
Design		 厦门鹭伏特新能源科技有限公司 Xiamen Egret Solar New Energy Technology Co., Ltd	
Chk'D			
App'V'D			

EGRET SOLAR  
YOUR SOLAR BUTLER

EGRET SOLAR  
YOUR SOLAR BUTLER

EGRET SOLAR  
YOUR SOLAR BUTLER

EGRET SOLAR  
YOUR SOLAR BUTLER

EGRET SOLAR  
YOUR SOLAR BUTLER

EGRET SOLAR  
YOUR SOLAR BUTLER

EGRET SOLAR  
YOUR SOLAR BUTLER

EGRET SOLAR  
YOUR SOLAR BUTLER

EGRET SOLAR  
YOUR SOLAR BUTLER

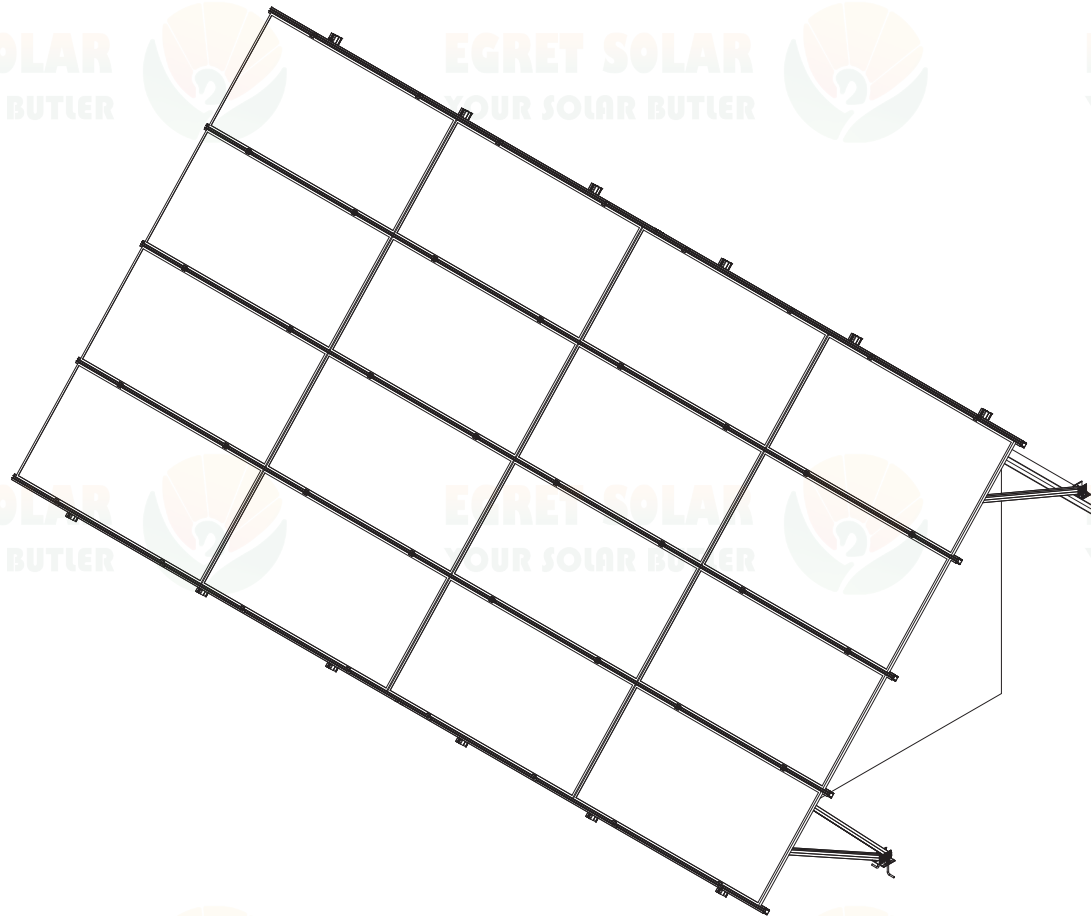

Installation Complete

Version	Date	Approval	Change mark	Description of Change
A				

Project Name	Container systems	Project No.	EG20230510
Design		 厦门鹭伏特新能源科技有限公司 Xiamen Egret Solar New Energy Technology Co., Ltd	
Chk'D			
App'V'D			